

Overview: Spare Parts for **safetec** Fan Units

Type	Version (Serial Nos.)	Spares (Type, safetec Art.No.)	Layout
SDS-M0420	From 420.0010	<ul style="list-style-type: none"> • Motor: Elektor, Art.No. FAN01.002-nicht mehr lieferbar • Capacitor: Type 20µF, Art.No. FAN01.003 • <u>Alternative:</u> Hanning, Art.No. FAN02.122 (9kg) • Capacitor: Type 12µF, Art.No. FAN02.115 • V-Belt: Art.No. FAN01.006 • Impeller: Art.No. FAN02.019 • Motor Holder: Art.No. FAN02.213 • Ball Bearing: Type: 6202-2ZC3 Art.No. FAN02.036 Type: 6205-2ZC3 Art.No. FAN01.010 • <u>Alternative:</u> Module including 1 motor with holder, impeller and v-belt Art. No. FAN01.001 	Keilriemenantrieb 60kg 
SDS-M0430 230V (50kg)	Version 1: 430.0010 to 430.1530	<ul style="list-style-type: none"> • Motor: EMOD, Art.No. FAN02.100 *) • Capacitor: Type 16µF, 450V AC, Art.No. FAN02.111 • Impeller: Art.No. FAN02.004 – not available anymore. Alternative: Art.No. FAN02.016 • Motor Holder: Art.No. FAN02.003 **) • Ball Bearing: Type: 6202-2RS1 Art.No. FAN02.029 	
	Version 2: 430.1540 to 430.5290	<ul style="list-style-type: none"> • Motor: Type EMOD, Art.No. FAN02.100 *) • Capacitor: Type 16µF, 450V AC, Art.No. FAN02.111 • Impeller: Art.No. FAN02.004 – not available anymore. Alternative: Art.No. FAN02.016 • Motor Holder: Art.No. FAN02.003 **) • Ball Bearing: Type: 6202-2RS1 Art.No. FAN02.029 	
	Version 3: From 430.5300	<ul style="list-style-type: none"> • Motor: Type Hanning, Art.No. FAN02.121 • Capacitor: Type 10µF, 450V AC, Art.No. FAN02.116 • Impeller: Art.No. FAN02.016 • Ball Bearing: Type 6202-2ZC3 Art.No. FAN02.036 Type 6204-2ZC3 Art.No. FAN02.037 	
SDS-M0431 110V	431.010 to 431.160	<ul style="list-style-type: none"> • Motor: Type Hanning, Art.No. FAN02.131 • Capacitor: Type 40µF, 450V AC, Art.No. FAN02.114 • Impeller: Art.No. FAN02.016 • Ball Bearing: Type 6202-2ZC3 Art.No. FAN02.036 Type: 6204-2ZC3 Art.No. FAN02.037 	
SDS-M0440 230V	From 440.1	<ul style="list-style-type: none"> • Motor: Type Hanning, Art.No. FAN02.121 • Capacitor: Type 10µF, 450V AC, Art.No. FAN02.116 • Impeller: Art.No. FAN02.017 • Ball Bearing: Type 6202-2ZC3 Art.No. FAN02.036 Type 6204-2ZC3 Art.No. FAN02.037 	
SDS-M0441 110V	From 441.1	<ul style="list-style-type: none"> • Motor: Type Hanning Art.No. FAN02.131 • Capacitor: Type 40µF, 450V AC, Art.No. FAN02.114 • Impeller: Art.No. FAN02.017 • Ball Bearing: Type 6202-2ZC3 Art.No. FAN02.036 Type 6204-2ZC3 Art.No. FAN02.037 	

*) Motor type is not available anymore.
Alternative deliverable arrangement, comprising with
FAN02.121 + FAN02.006 + FAN02.016 + FAN02.023 + FAN02.035 + MET01.020 + MET01.021 (siehe Zng.)

***) Motor holder is not available anymore.
Remark:
Exchange of ball bearings of motor holder is complicated and hardly to be done proper without special Tools. When extracting the impeller it may come to an unbalance which may create vibrations and ball Bearing damage if not properly balanced again.
Alternative: Pre-assembled driving module, Art.No. BG01.400 comprising with 8, 9, 10, 11, 12. (12kg)

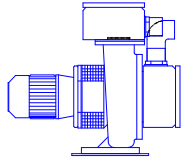
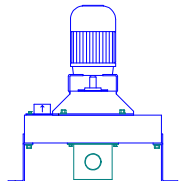
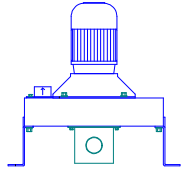
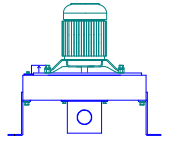
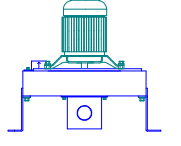
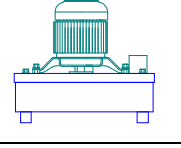
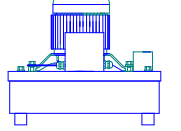
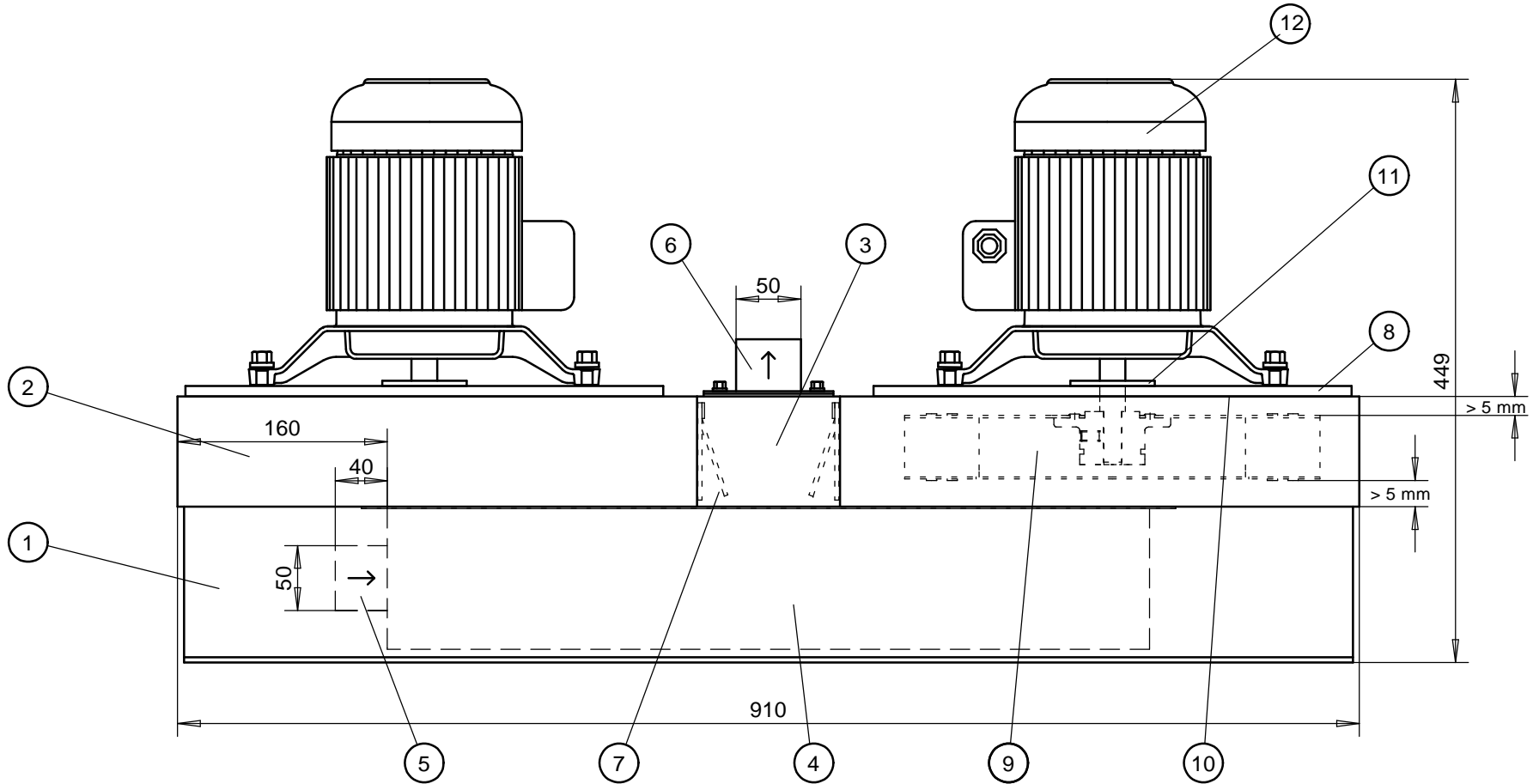

- 1 Befestigungswinkel
Mounting Angle
- 2 Laufradgehäuse
Impeller Housing
- 3 Sammelkanal Druckseite
Air Outlet Manifold
- 4 Sammelkanal Ansaugseite
Air Inlet Manifold
- 5 Lufteintritt / Air Inlet

- 6 Luftaustritt / Air Outlet
- 7 Rückschlagklappe
Non Return Flap
- 8 Abdeckplatte
Cover Plate
- 9 Lüfterrad / Impeller
- 10 Flachdichtung / Flat Sealing

- 11a Dichtring / Sealing
Art.No. FAN02.035
- 11b Stützring / Ring
Art.No. MET01.020
- 11c Deckel / Cover
Art.No. MET01.021
- 11d Schraube / Screw
Art.No. V01.042

- 12 Motor
ab / from serial No. 430.5300:
Art.No. FAN02.121
- 12a Kugellager Wellenseite
Ball Bearing Shaft Side
Type 6204 2Z C3
Art.No. FAN02.037
- 12b Kugellager gegenüber
Ball Bearing opposite
Type 6202 2Z C3
Art.No. FAN02.036

Remark (Art.No. BG01.400):
Pre-Assembled driving-
module consisting of:
Pos. 8, 9, 10, 11, 12
for conversions from
previous to current
version.

Gültig ab Seriennummer 430.5300
Valid from Serial No. 430.5300 on