

Additional Fault Finding Instructions for Smoke Detection System SDS-2/6

safetec Brandes und Niehoff GmbH
Arenskule 7-9
D-21339 Lüneburg
Germany
Tel.: ++49 - 4131 – 7670-200
Fax.: ++49 - 4131 – 7670-201

Contents

- Fault Finding Table (Quick Reference)
- Fault Finding of Airflow Faults
- Fault Finding of Data Transfer Faults
- Fault Finding of Smoke Detector Faults
- Problems with Fuses on Power Supply Module

Drawings

- Wiring Diagram Smoke Detectors, Airflow Indicators, Zener Barriers BG01.724
- Configuration Tables SDS01.100.80 - SDS01.100.88

Fault Finding Table

Faults (on the LCD)	Possible Reasons	Correction
CHECK : Fan -x-	All 3- way valves were shortly closed.	1. Check position of 3-way valves 2. Switch-over to stand-by fan aggregate
	Fuse(s) of fan aggregate on power supply module defect	Correct faults Exchange fuse
	Fan -x- defect	Exchange fan
CHECK : Valves and Fans	All 3- way valves in wrong position.	Set 3- way valves in air sampling position
	Both fan aggregates are defect.	Repair or exchange fan aggregates
FAULT : Airflow Line -x-	3- way valve in wrong position.	Check position of 3- way valve
	Detection line is clogged.	Send compressed air through detection line. Ensure all 3- way valves are closed in way to smoke detection panel during this procedure
FAULT : Data Transfer Device -x- <i>Note: The correlation of the different "device" nos. to the system components is listed on the rear side of the door of the smoke detection panel</i>	Defective fuse in device -x-.	1. Eliminate fault 2. Exchange fuse
	Device address no. of device -x- is not correctly adjusted.	Adjust correct device address no. (refer to section 6)
	Cable connection to device -x- (RS-485-Bus) is incorrect	Check cable connection
	Device -x- is defective	Replace device -x-
<i>only fire alarm panel:</i> FAULT : Data Transfer	Fuse in repeater panel is defective.	1. Eliminate fault 2. Exchange fuse
	Connection (RS-485-Bus) at repeater panel is incorrect	Check cable connections
FAULT : Dirt in Line -x-	Smoke detector with internal residue.	Clean smoke detector
FAULT : Emergency Supply	Breakdown of ship emergency power supply circuit on ship.	Re-establish circuit
FAULT : Main Supply	Breakdown of ship main power supply circuit on ship.	Re-establish circuit
FAULT : Smoke Detector Line -x-	Smoke detector -x- is not installed.	Insert smoke detector
	Smoke detector is defective.	Change smoke detector
FIRE : Line -x- (but smoke cannot be verified)	ID no. x is attached to more than one smoke detector	Change ID nos. of smoke detector to correct setting (refer to 5.3.2)
	After cleaning the smoke detector, the labyrinth has not been correctly reassembled.	Ensure, that the snapping lugs of the labyrinth are snapped completely over the PCB (refer to section 5.3.3)

Further Fault	Possible Reason	Correction
Contrast of LCD is too weak or too strong	Contrast control is not adjusted	Adjust contrast intensity at the adjustable resistor on the rear side of indication / control module
LCD does not display any information, all fields are dark	High electrostatic discharge upon the display	Switch off Smoke Detection System shortly by quickly pulling out Fuse F1 on power supply module
Fan units with v-belt only: Fan unit too loud	Tension of v-belt incorrect	Adjust tension of v-belt

Fault Finding of Airflow Faults

Fault Indication: “FAULT Airflow all lines” or “FAULT: Airflow Line -x-y-z-“

- Ensure one of the fans is running.
- Ensure 3-way-valves are open.
- Ensure upper door of the smoke detection panel / extension unit is closed.
- Ensure covers of the detector boxes are closed and screws of covers are tightened.
- Disconnect hoses at the smoke detection panel / extension unit to ensure airflow through smoke detection panel / extension unit.
- Open the upper door of the smoke detection panel / extension unit and remove cover of airflow indicator. Remove wire from terminal no.3 in the airflow indicator and connect this wire together with the other wire to terminal no.1 (short circuit). Now the fault indication of this line must disappear. If the fault indication disappears, the airflow indicator must be exchanged. If the fault indication for this line is still present, it must be an electrical problem, not a problem of the airflow.

For further examinations of the electrical wiring and components, please refer to drawing no. BG01.720.4. Please note, that airflow indicators for line 1-3 are connected to terminal nos. 33/34 and airflow indicators for line 4-6 are connected to terminal nos. 35/36 at the detector interface module.

- Check the wiring between resistor - PCB and appropriate zener barrier.
- Check the wiring between resistor - zener barrier and detector interface module.
- Measure the voltage between terminal nos. 34/18 and between terminal nos. 36/18 at the detector interface module. Both values must be 15V. These voltages are supply for the multiplexed signals of the airflow indicators.
- Measure the voltage between terminal nos. 33/18 resp. 35/18 at the detector interface module. These voltages are the output signals of the airflow indicators. The values must be as follows:

Line 1-3	
Situation: Airflow is present at the following Line Nos.:	resulting Voltage at Terminal Nos. 33/18 [V]
1, 2 and 3	4,93
2 and 3	4,55
1 and 3	4,10
3	3,58
1 and 2	2,95
2	2,18
1	1,23
No airflow	0

Line 4-6	
Situation: Airflow is present at the following Line Nos.:	resulting Voltage at Terminal Nos. 35/18 [V]
4, 5 and 6	4,93
5 and 6	4,55
4 and 6	4,10
6	3,58
4 and 5	2,95
5	2,18
4	1,23
No airflow	0

Table 1a and 1b

- If the measured voltages are correct, but fault indication is still present, the detector interface module must be exchanged.
- If the measured voltages are not correct compared with table 1, disconnect the wires at the terminal nos. 33/34 at the detector interface module. Measure the resistance between the disconnected wires and compare with the following table:

Situation: Airflow is present at the following Line Nos.:	Resistance [Ω]	Resistor-PCB at terminal nos. 47/48 (without Zener Barrier) [Ω]
1, 2 and 3	1044	784
2 and 3	1174	914
1 and 3	1357	1097
3	1631	1371
1 and 2	2087	1827
2	3001	2741
1	5741	5481
No airflow	∞	∞
Values for line nos. 4 - 6 are corresponding		

Table 2

- If the measured values are not correct compared to table 2, disconnect the wires of the zener barrier and measure the resistance of the zener barrier between terminal nos. 4/5 and terminals nos. 1/8 (130 Ohm each path).
- If the measured values are not correct, the zener barrier is defect.
- If the measured values are correct, the resistor - PCB must be defect. For verification measure the resistance of the resistor - PCB between terminal nos. 47/48 and compare with table 2, column no.3.

Fault Finding of Data Transfer Faults

General Information

The following components of the smoke detection system SDS are connected by a 4-wire-bus (RS485-bus):

Name of Component	Function	Address – No.
Indication- / control module in smoke detection panel	Master	No address
Detector interface module in smoke detection panel	Slave	1
Detector interface module in extension unit no.1	Slave	2
Detector interface module in extension unit no.2	Slave	3
Indication- / control module in repeater panel	Slave	Next successive no., depending from no. of extension units

The master calls successively all slaves to send data (for example: status of smoke detectors and airflow indicators). This data will be read and displayed by the master and by the repeater panel.

Each slave has an adjustable address-no. The address no. of a component serves for internal and external identification of a component.

In case of a fault the component with the address “x” will be displayed as “Device –x-“ on the LC-display.

The no. of slaves to be called by the master must be adjusted by a rotary switch at the rear side of the indication- / control module in the smoke detection panel.

The bus cable supplies electrical power for the slaves (24V DC) and is used for data exchange between all modules. In all components, the terminals for the bus cable are labeled with the same terminal-nos.:

Terminal-No.	Function
17	Power Supply +24V DC
18	Power Supply 0V
19	Data Bus Signal A
20	Data Bus Signal B

All components must be connected by the bus cable in a line (not in form of a star !). At both ends of the line the bus must be terminated with a resistor 120 Ohm. In most cases one of the ends is in the repeater panel, the other end is in the smoke detection panel or in the last extension unit. The sequence of the components within the line needs not to follow the sequence of address nos.

Fault Indication “FAULT: Data Transfer”

This fault indication without display of any device no. appears only on the repeater panel. It means, that no call of the master reaches the controller of the indication- / control module in the repeater panel. Therefore no other faults can be displayed.

Please check the following:

- Check setting of rotary switch at indication- / control module in smoke detection panel. The adjusted no. determines the no. of called slaves.
- Check setting of rotary switch at indication- / control module in repeater panel. The adjusted no. determines the address-no. of the repeater panel.
- Ensure, that the address-no. of the repeater panel is not assigned to another component.
- Check the fuses on the adapter – pcb of the repeater panel.
- Ensure correct bus-cable connection to the repeater panel. Note: In most cases the cable between smoke detection panel and repeater panel is lead through a cable connection box. This bears the risk of a mix-up of the 4 wires. If you are not sure, whether the connection is correct, please proceed as follows:
Go to the smoke detection panel and disconnect the wires to terminal nos. 19/20 from the cable which connects the repeater panel. Switch on power supply. Go to the repeater panel and find out the wires which carry 24V (20 – 28 V). Connect the plus-pole to terminal no.17 and the minus-pole to terminal no.18 in the repeater panel. When power is on, the green lamp of the repeater panel must be lighted now. Now connect the remaining wires to terminal nos. 19/20. If the a.m. fault indication is still present, please exchange the wires at terminal nos. 19/20. Now the repeater panel should be connected to the master.

Fault Indication “FAULT: Data Transfer Device -x-”

This fault indication shows the address of the component, which is not detected by the master or by the repeater panel. Please check the following:

- Check setting of rotary switch at indication- / control module in smoke detection panel. The adjusted no. determines the no. of called slaves.
- Check the setting of the rotary switch of the component, which shall have the address no. “x”.
- Ensure that this address no. is not assigned to any other component.
- Check the wire connections of the bus-cable.
- Check fuses of the component with address-no. “x”.

Fault Indication **“FAULT: Data Transfer Device -1-2-3- ... ”**
(all connected components are indicated as faulty)

When the fault indication lists all addressable components, please check the following:

- Check setting of rotary switch at indication- / control module in smoke detection panel. The adjusted no. determines the no. of called slaves.
- Check fuses F3/F4 on power supply module (fuses for bus signal A and B to master).
- If fault indication is still present, a fault in bus-cabling could prevent complete data exchange between all components. To locate this fault, please disconnect all bus-cables in the smoke detection panel. As a result, the fault indication for “Device-1-” should disappear, because this component (detector interface module in smoke detection panel) is connected internally to the master.
- Reconnect “Device-2-“. Let all other components be disconnected. Now the fault indication for “Device-2-” should disappear. However if again all connected components are indicated as faulty, the wiring to “Device-2-” is not correct or the component itself is defective.
- Reconnect all remaining components accordingly one by one.

Note:

- For setting of rotary switches please also refer to drawing nos. SDS01.100.80 - SDS01.100.88.
- Changing of rotary switches will not be valid before power down and restart of the smoke detection system.

Fault Finding of Smoke Detector Faults

General Information

Max. 6 smoke detectors are connected to one smoke detection panel or to one extension unit. Each smoke detector has a DIP-switch on its rear side to assign its ID-no. Note that only the values 1 – 6 are allowed (also in the extension units with higher line nos. !). The indication of a smoke detector on the LC-Display depends on its ID-No. and its position in the smoke detection panel or in a extension unit. The smoke detectors in the smoke detection panel will be displayed as “Smoke Detector Line -1-“ up to “ Smoke Detector Line -6-“. The smoke detectors in the extension unit no.1 will be displayed as “Smoke Detector Line -7-“ up to “ Smoke Detector Line -12-“ and so on.

Electrically up to 6 smoke detectors are connected in one line to one detector interface module via a zener barrier for intrinsically safe operation.

Fault Indication: “FAULT Smoke Detector Line -x-“

Please check the following:

- Smoke detector in line “x” is inserted in its base.
- Smoke detector in line “x” has the correct ID-no.
- The ID-No. of this smoke detector has not been assigned to any other smoke detector in this smoke detection panel / extension unit

Fault Indication: “FAULT Smoke Detector Dirt in Line -x-“

The smoke detector in line “x” is dirty. Please refer to the instruction: “Cleaning of Smoke Detectors” on the next page.

No Fire Indication, but Smoke is present

- Ensure that appropriate detector interface module is working. For example: If “FAULT Data Transfer Device -1-“ is indicated, no Fire alarm or airflow fault from line 1 - 6 can be transmitted.
- Check setting of the lower rotary switch on the detector interface module. If 6 smoke detectors are connected to the detector interface module, the lower rotary switch must be adjusted to “6”.

Alarm Indication: “FIRE Line -x-“, but no smoke is present

Check the setting of the ID-Nos. of all smoke detectors in the panel. The ID-No. for line “x” might be assigned to more than one smoke detector.

All smoke detectors of the smoke detection panel or extension unit indicate “FIRE”, but no smoke is present

Please disconnect the wires at terminal nos. 31/32 at the detector interface module. If the alarm indication is still present, the detector interface module is defective and must be exchanged. If the alarm is not displayed after disconnection of the wires, a short circuit in the smoke detector line including the zener barrier is probable. Disconnect the zener barrier and measure the resistance between 5 and 8. If a short circuit will be indicated, the zener barrier must be replaced. If no short circuit has been found in the zener barrier, the short circuit must be located in the wiring of the smoke detectors. Please note, that all smoke detectors are connected in one line. Remove all smoke detectors in this panel. No short circuit may be measured between terminal no.1/3 or between terminal no.1 and enclosure or between terminal no.3 and enclosure.

Note:

- For setting of rotary switches please also refer to drawing nos. SDS01.100.80 - SDS01.100.88.
- Changing of rotary switches will not be valid before power down and restart of the smoke detection system.

Cleaning of Smoke Detectors

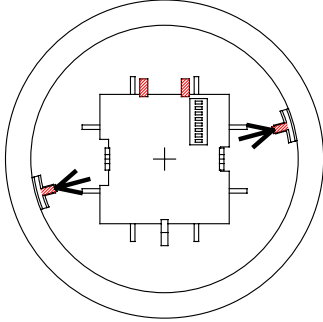
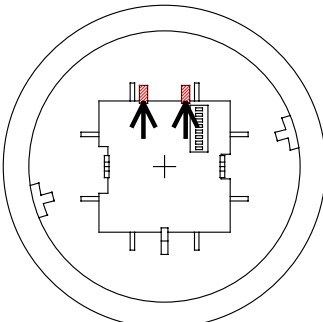
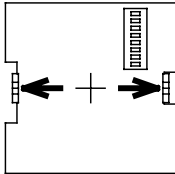
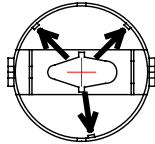
<p>1</p> <p>Push back snapping lugs of outer protection cap and remove outer protection cap</p>	 <p>Smoke detector from below</p>
<p>2</p> <p>Remove PCB by carefully pushing back snapping lugs</p>	
<p>3</p> <p>Remove detection chamber by carefully pushing back snapping lugs</p>	 <p>PCB from below</p>
<p>4</p> <p>Open labyrinth by carefully pushing back three snapping lugs</p>	 <p>Labyrinth from below</p>

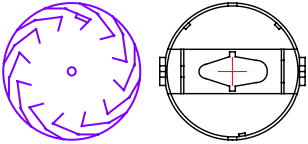
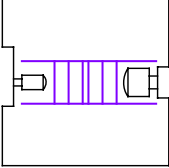
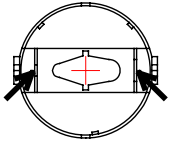
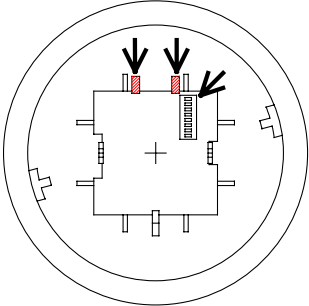
<p>5</p> <p>Clean both parts of labyrinth with compressed air. Ensure, that the small white reflector in the optical chamber is clean.</p> <p>If there are sticky residues, the labyrinth may be cleaned with a mild soap solution or with isopropyl alcohol.</p>	 <p>Labyrinth and base of labyrinth</p>
<p>6</p> <p>Remove dust on the photo - diode PCB with compressed air.</p> <p>If there are sticky residues, the lenses of the photo - diodes may be cleaned with a mild soap solution or with isopropyl alcohol.</p> <p>Polish the lenses of the photo - diodes with a smooth cloth.</p>	 <p>PCB with photo - diodes</p>
<p>7</p> <p>Reassemble labyrinth, snap the detection chamber onto the PCB.</p> <p>Ensure that the different recesses for the photo - diodes are placed correctly.</p> <p>Ensure that the snapping lugs are snapped completely over the PCB, otherwise fire alarm will be activated once the smoke detection panel is restarted.</p>	
<p>8</p> <p>Snap the detection chamber with PCB onto the base part.</p> <p>The DIP switches must be located to the right side of the snapping lugs.</p> <p>Snap on the outer protection cap.</p>	

Problems with Fuses on Power Supply Module (SDS-2/6)

Blown Fuse	Possible Reason
F1	Power supply module defective. Exchange power supply module.
F2	External short circuit on the bus cable. Please disconnect bus cable from terminal nos. 17, 18, 19 and 20 at the power supply module and start system again. If fuse does not break again, please examine the bus cable to locate the short circuit.
F5, F6	Short circuit in fan unit no.1. Please disconnect cable for fan no.1 at terminal nos. 5 and 6. and start system again. If fuse does not break again, please examine the cable and fan motor no.1 to locate the short circuit.
F6, F7	Short circuit in fan unit no.2. Please disconnect cable for fan no.2 at terminal nos. 7 and 8. and start system again. If fuse does not break again, please examine the cable and fan motor no.1 to locate the short circuit.

Smoke Detectors BH-31A/Ex (max. 6)

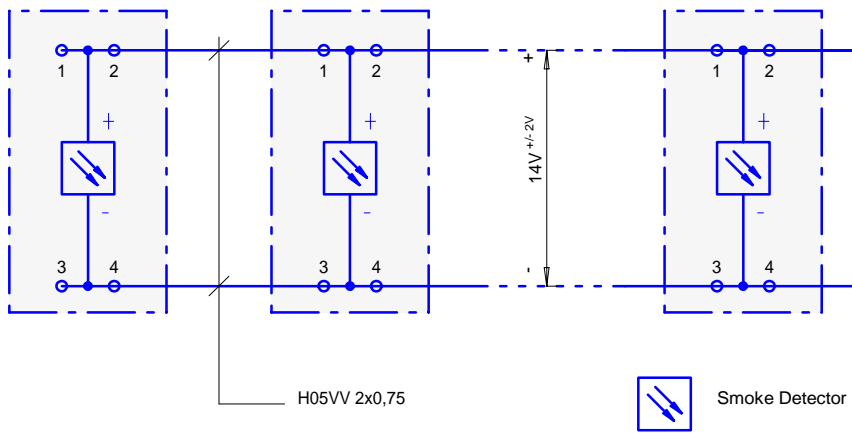

Upper Enclosure
Detection Unit
Hazardous Area

Lower Enclosure
Evaluation Unit
Safe Area

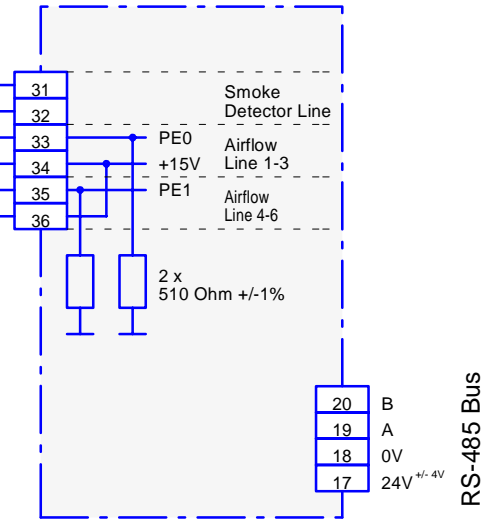
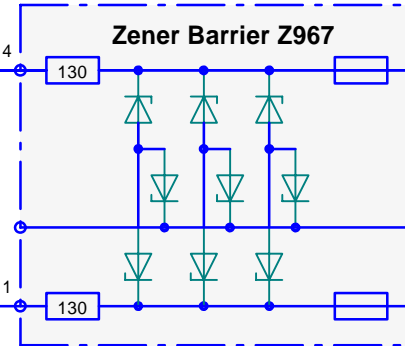

Detector Interface Mod.
BG01.700
BG01.720
BG01.730

Airflow Indicator Line 1 - 3 (Line 4 - 6 corresponding)

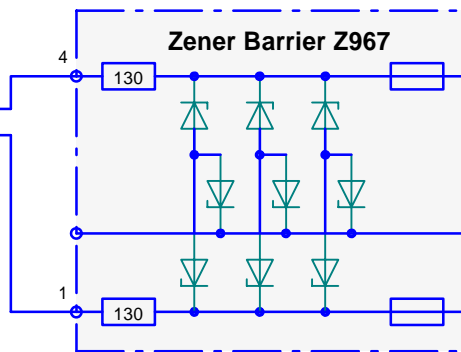
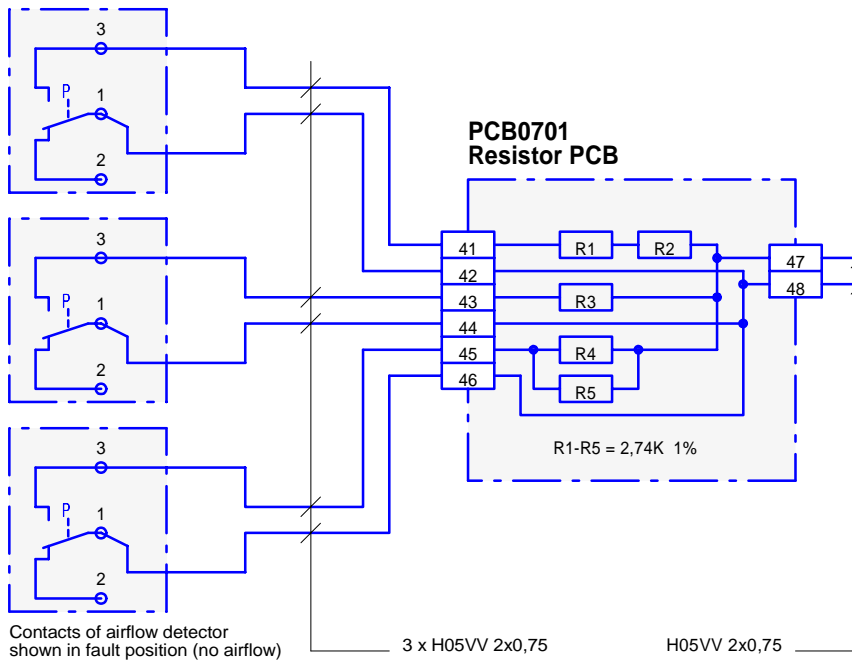

Airflow Indicator Line 4 - 6

Smoke Detection Panel SDS-2/6

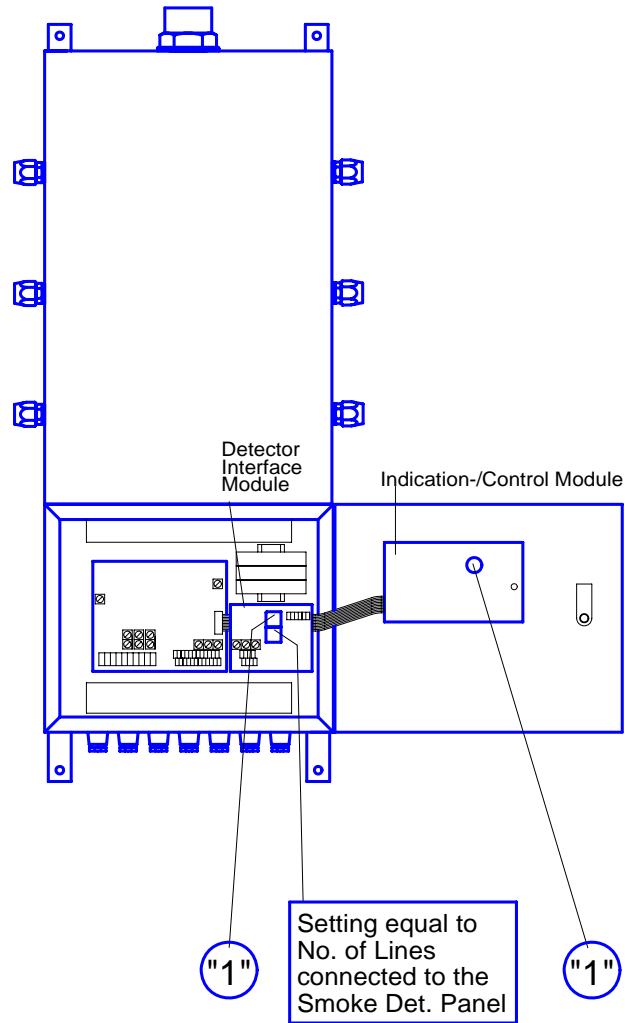

Legend: "1" Value for Setting the Rotary switch
┌─┐ End-of-Line-Resistors not required
 - - - Cablework for Interconnection

Smoke Detection Panel SDS-2/6

Repeater Panel

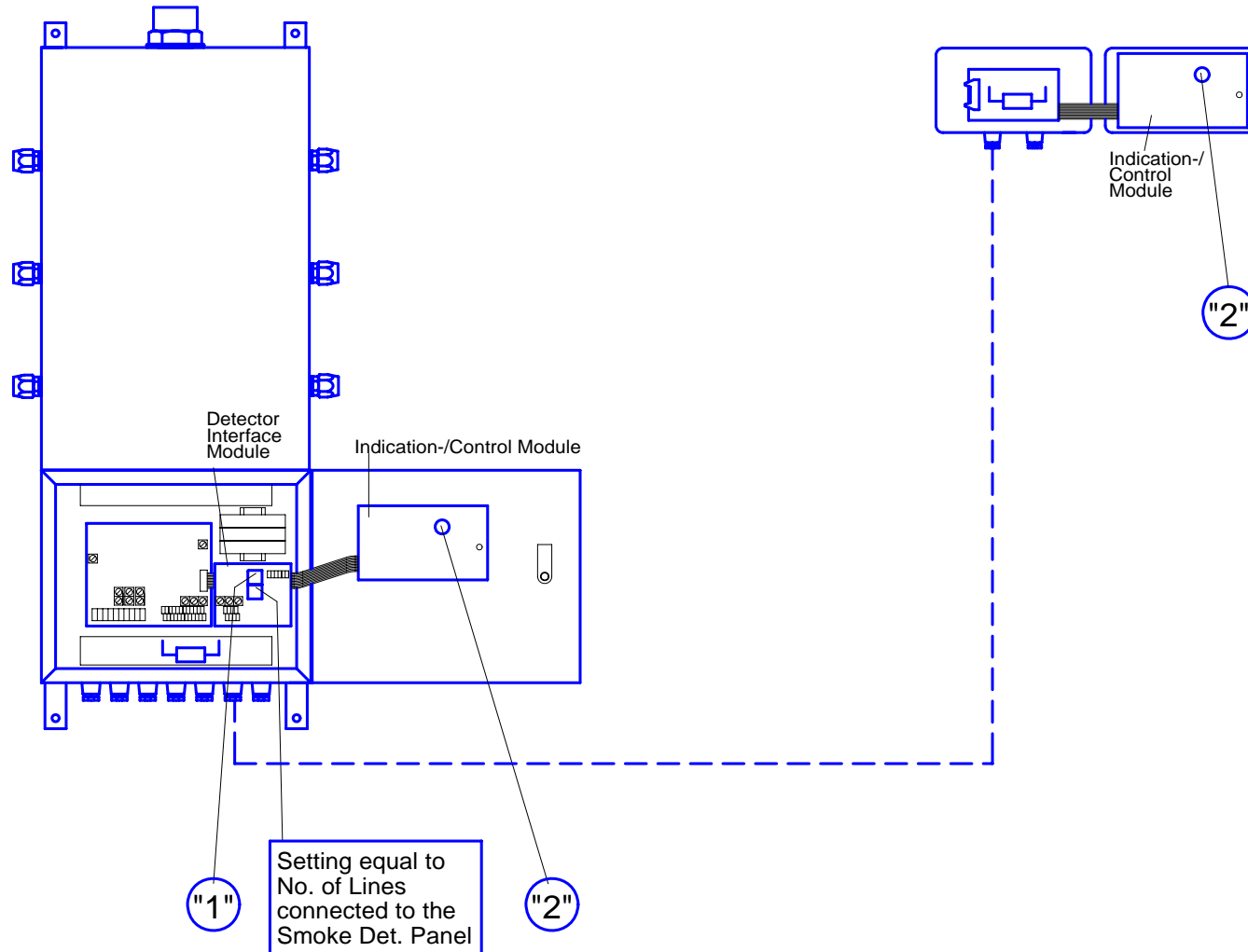

Legend: "1" Value for Setting the Rotary switch

 Connect End-of-Line-Resistors (120 Ohm) to Terminal 19/20 in Smoke Det. Panel and Repeater Panel

 Cablework for Interconnection

Smoke Detection Panel SDS-2/6

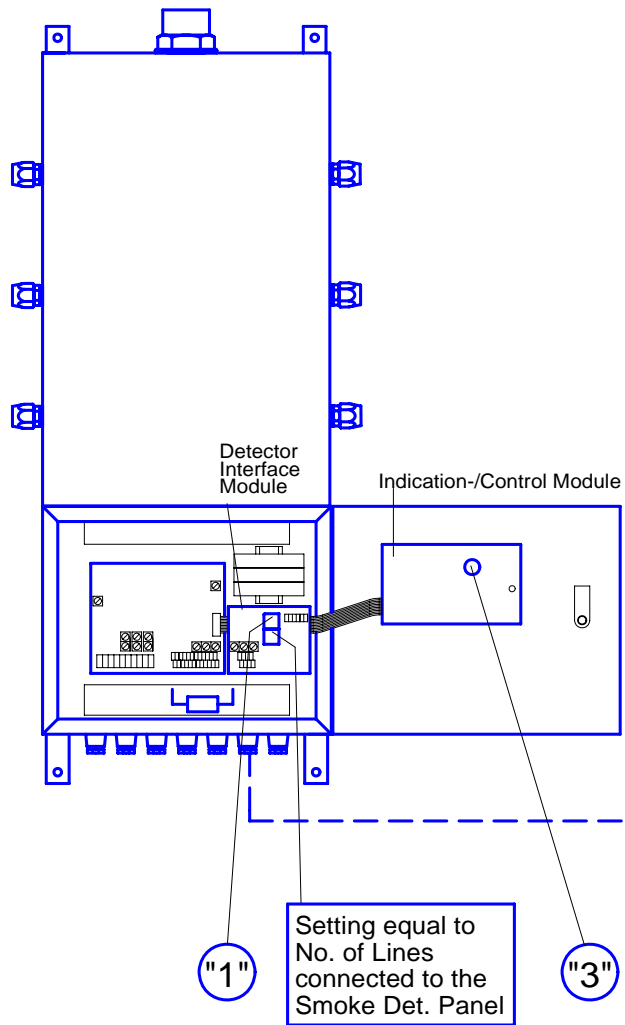

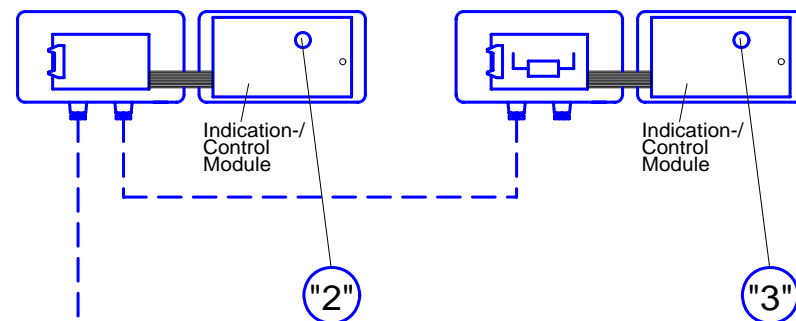

Repeater Panel No. 1

Repeater Panel No. 2



Legend:

- "1"** Value for Setting the Rotary switch
-  Connect End-of-Line-Resistors (120 Ohm) to Terminal 19/20 in Smoke Det. Panel and Repeater Panel No. 2
-  Cablework for Interconnection

Smoke Detection Panel SDS-2/6

Extension Unit SDS-E2/E6

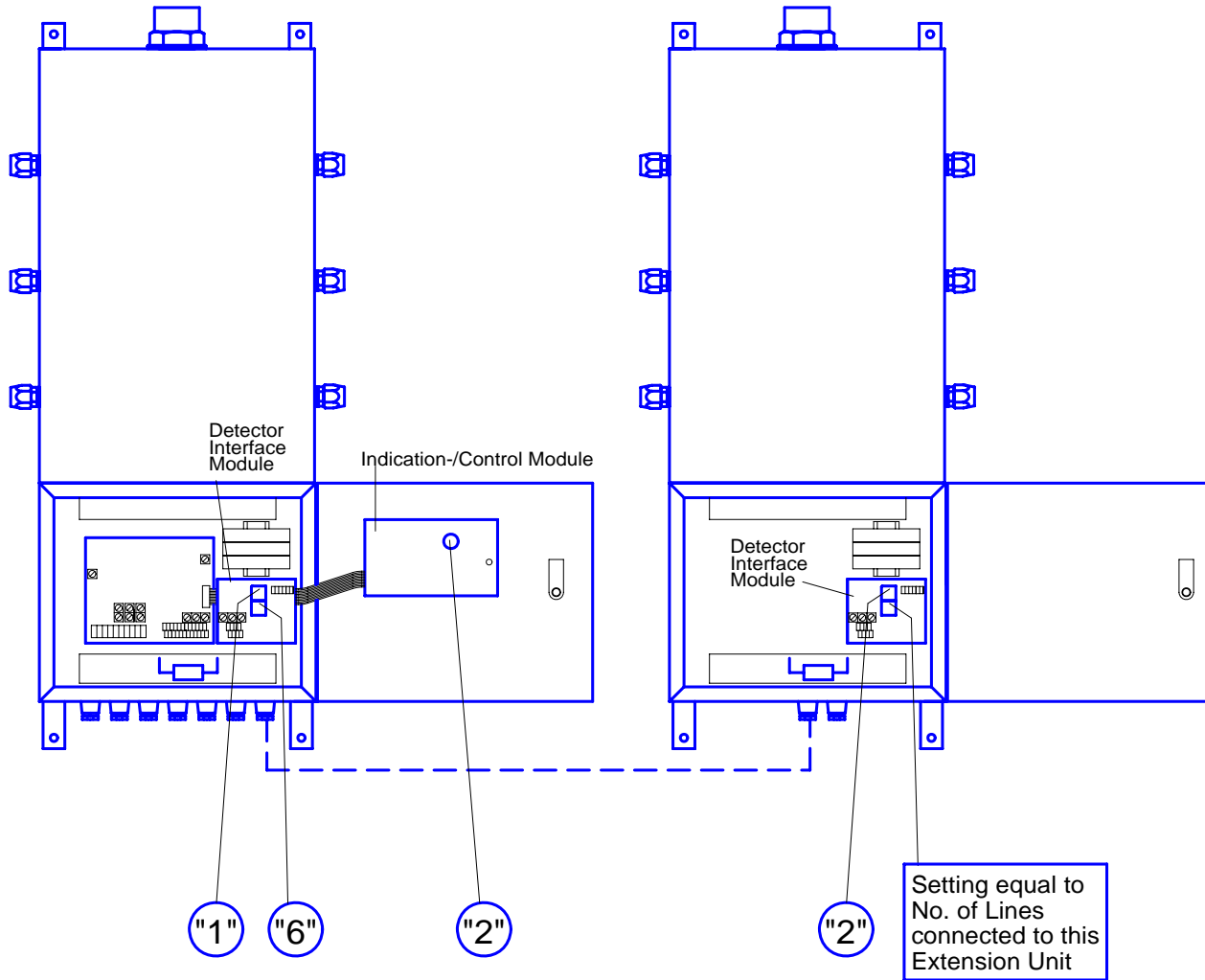

Legend: "1" Value for Setting the Rotary switch

 Connect End-of-Line-Resistors (120 Ohm) to Terminal 19/20 in Smoke Detection Panel and Extension Unit



 Cablework for Interconnection

Smoke Detection Panel SDS-2/6

Extension Unit SDS-E2/E6

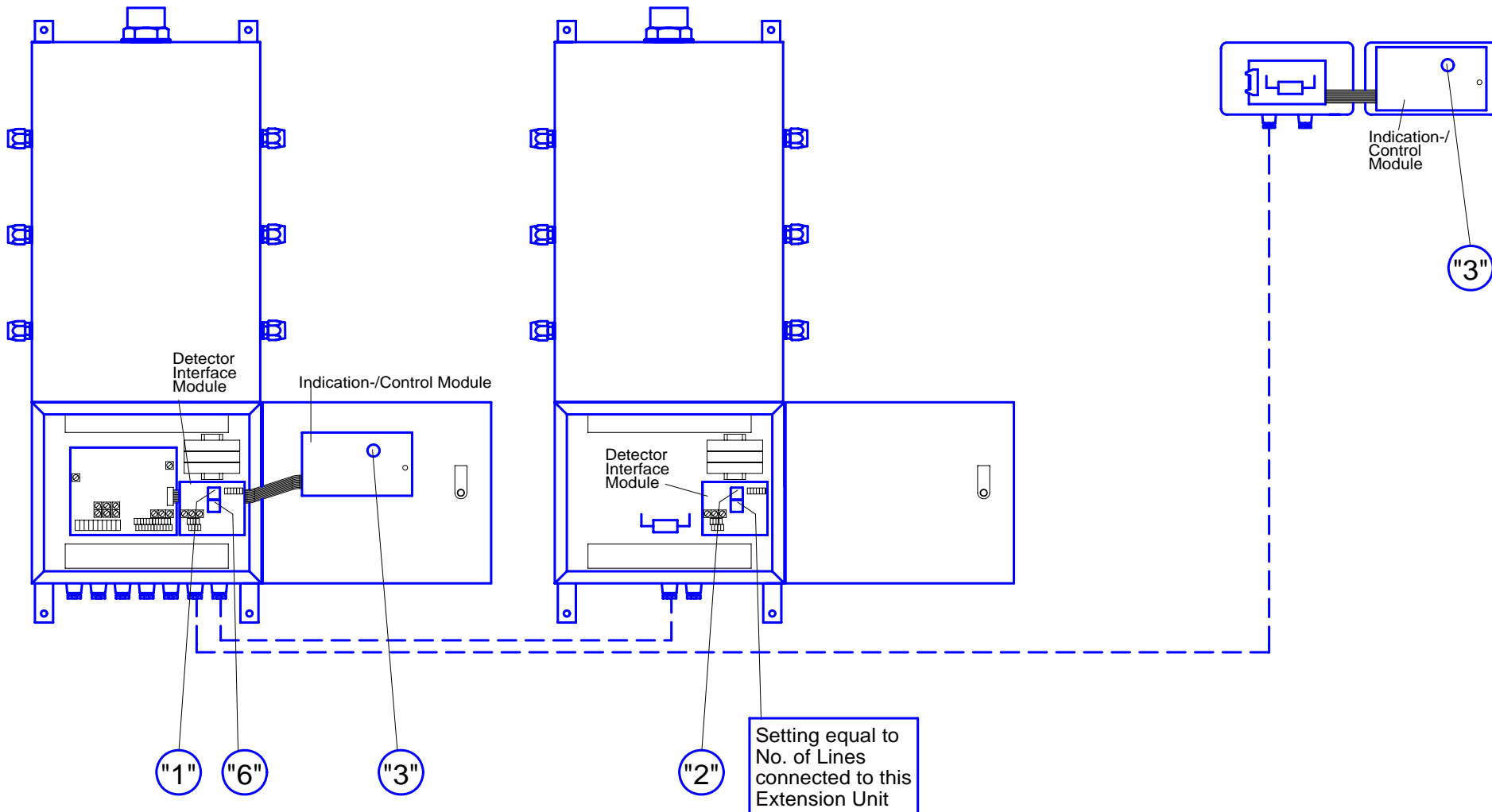
Repeater Panel



- Legend:
- "1"** Value for Setting the Rotary switch
 -  Connect End-of-Line-Resistors (120 Ohm) to Terminal 19/20 in Extension Unit and Repeater Panel
 -  Cablework for Interconnection

Smoke Detection Panel SDS-2/6

Extension Unit SDS-E2/E6

Repeater Panel No. 1

Repeater Panel No. 2

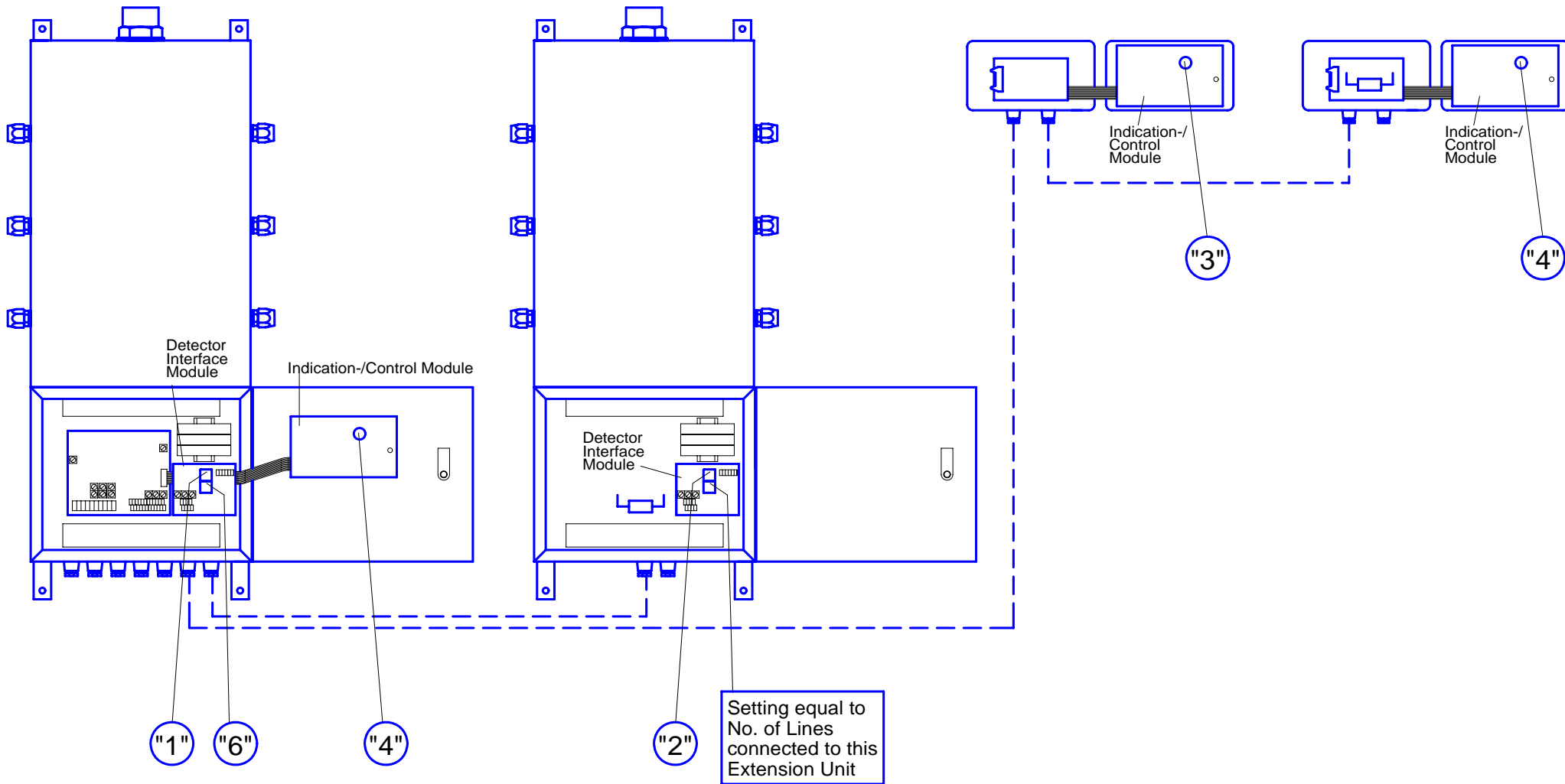

Legend: "1" Value for Setting the Rotary switch

Connect End-of-Line-Resistors (120 Ohm) to Terminal 19/20 in Extension Unit and Repeater Panel No. 2



Cablework for Interconnection

Smoke Detection Panel SDS-2/6

Extension Unit SDS-E2/6 No.1

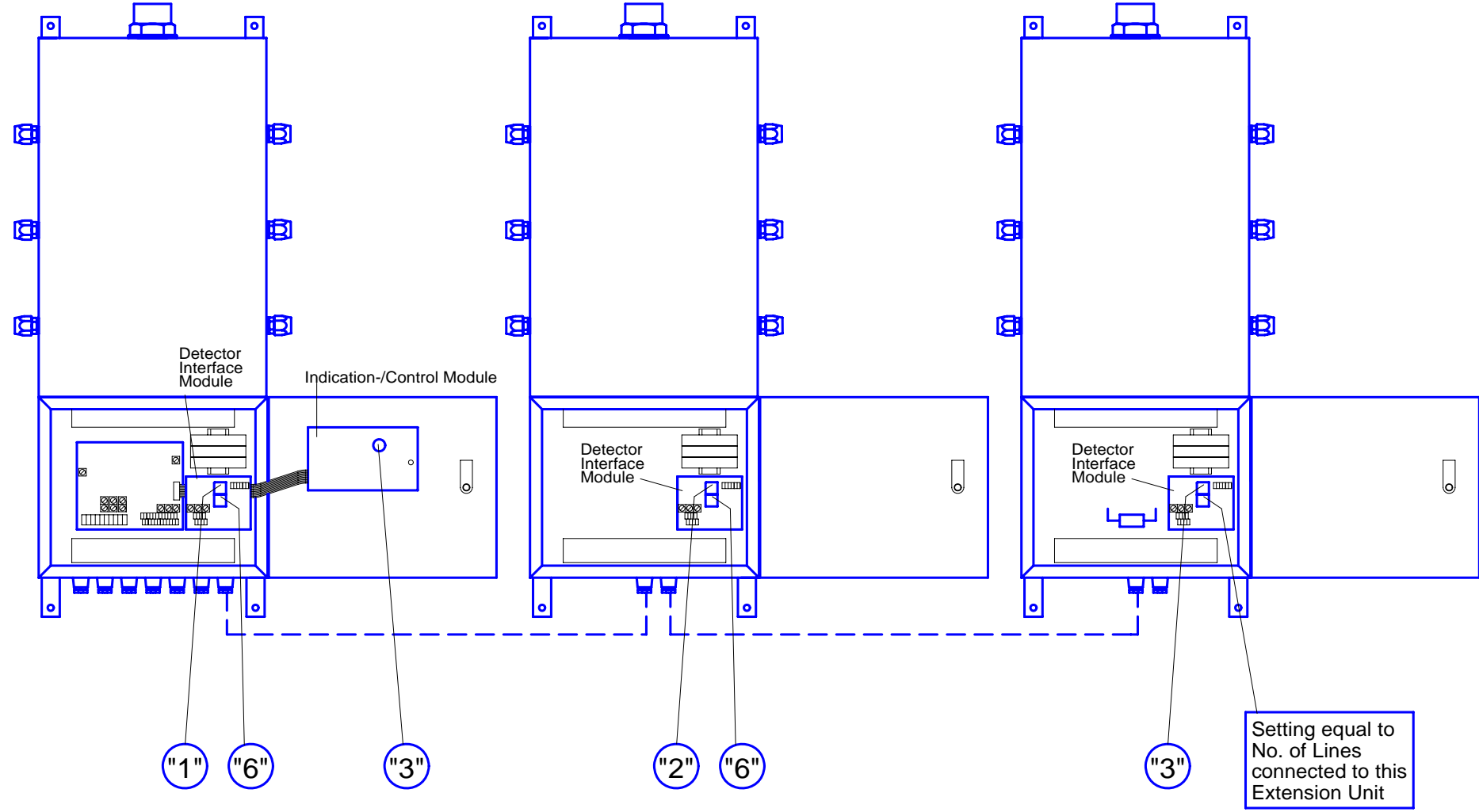
Extension Unit SDS-2/6 No.2



- Legend:
- "1" Value for Setting the Rotary switch
 -  Connect End-of-Line-Resistors (120 Ohm) to Terminal 19/20 in Smoke Det. Panel and Extension Unit No.2
 -  Cablework for Interconnection

Setting equal to
No. of Lines
connected to this
Extension Unit

Smoke Detection Panel SDS-2/6

Extension Unit SDS-E2/E6 No.1

Extension Unit SDS-E2/E6 No.2

Repeater Panel

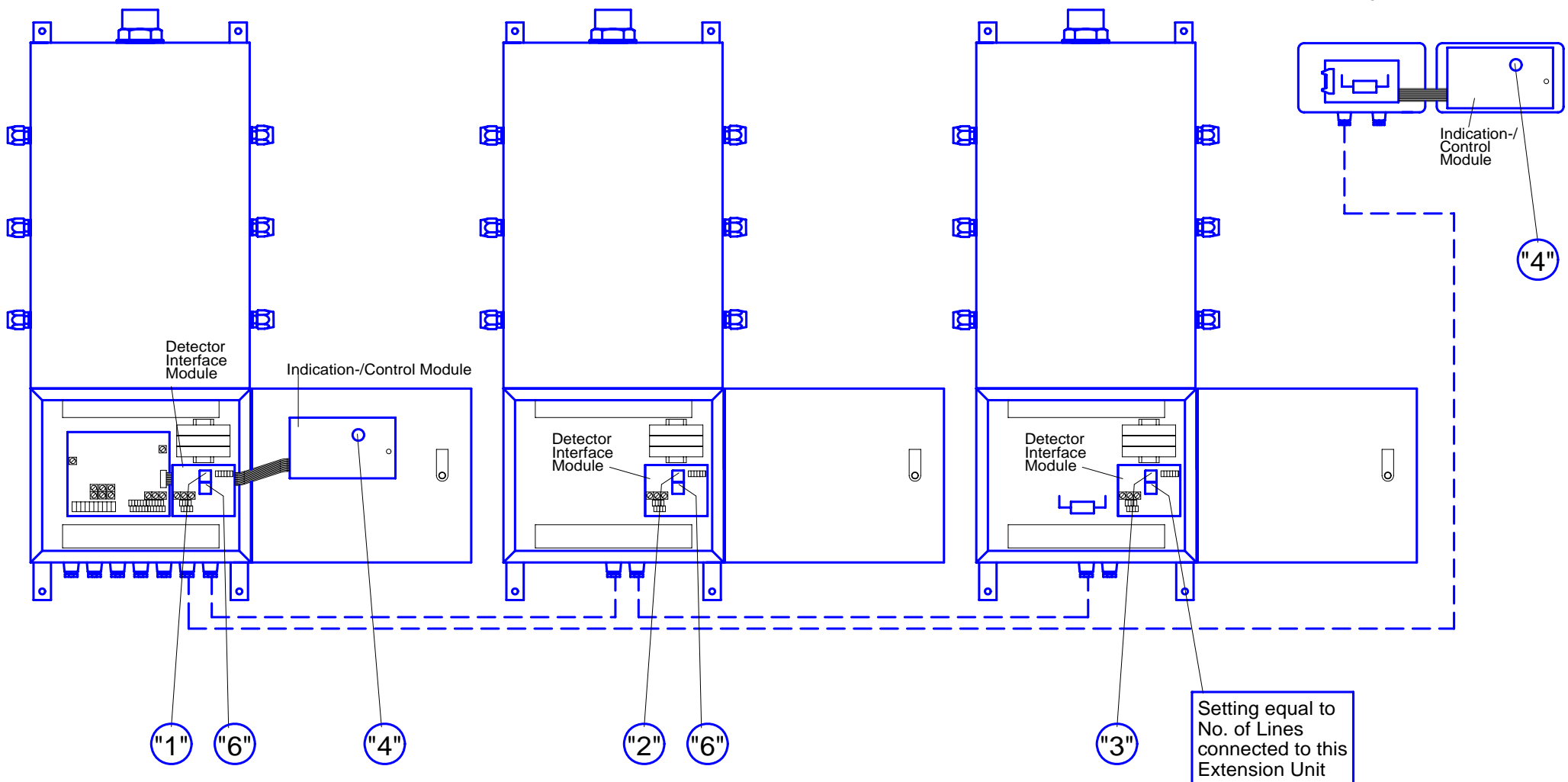

Legend: "1" Value for Setting the Rotary switch

Connect End-of-Line-Resistors (120 Ohm) to Terminal 19/20 in Extension Unit No.2 and Repeater Panel

Cablework for Interconnection

Smoke Detection Panel SDS-2/6

Extension Unit No.1

Extension Unit No.2

Repeater Panel No. 1 + 2

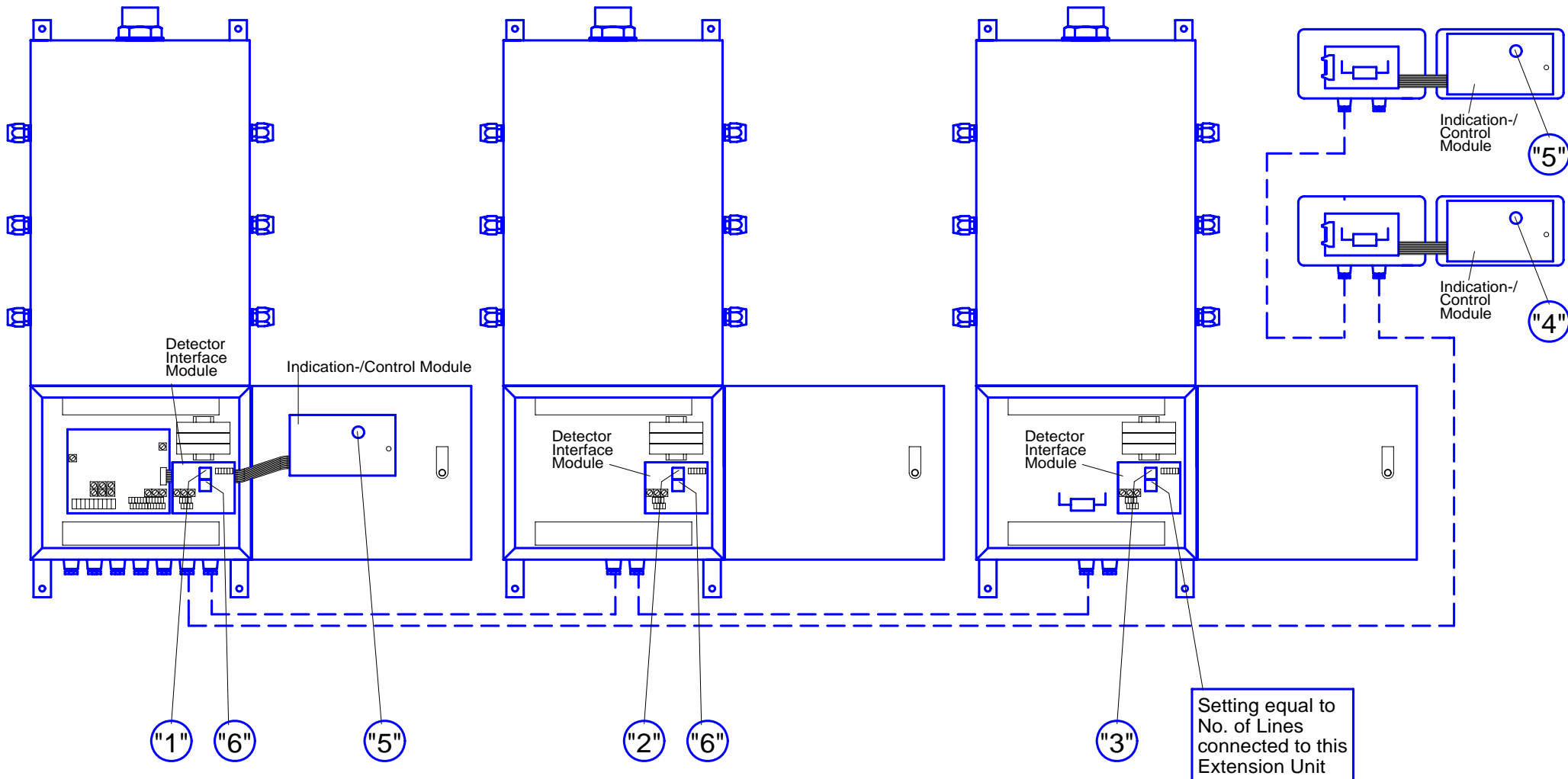

Legend: "1" Value for Setting the Rotary switch

 Connect End-of-Line-Resistors (120 Ohm) to Terminal 19/20 in Extension Unit No.2 and Repeater Panel

 Cablework for Interconnection

Setting equal to No. of Lines connected to this Extension Unit